

ActionJac 2-BSJ-IR 12:1

Call 800-321-7800 or visit us online at www.nookindustries.com to configure and order your ActionJac 2-BSJ-IR 12:1 today!

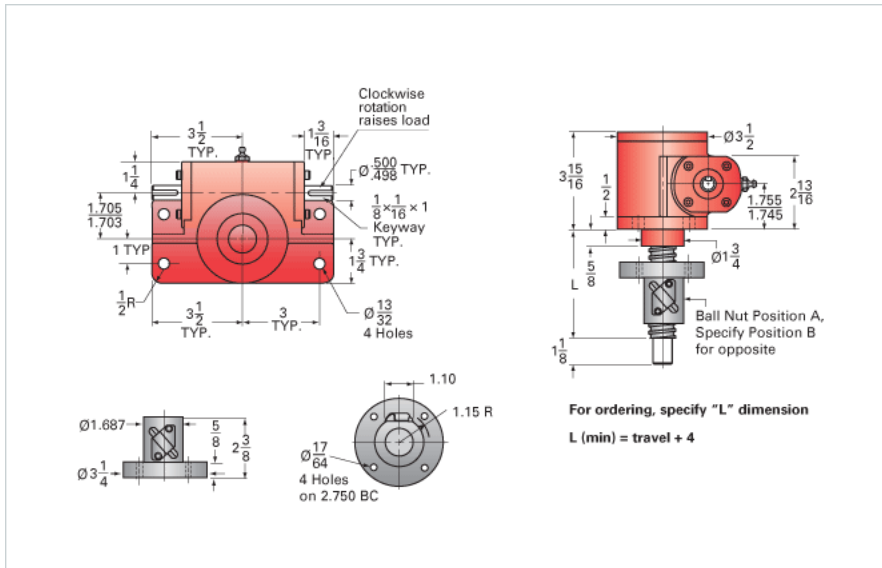

Details

Capacity [Ton]	2
Gear Ratio	12:1
Turns of Worm per Inch Travel	48
Torque to Raise 1 lb. [in-lb]	0.0064
Lifting Screw Diameter [in]	1.00
Screw Lead [in]	0.250
Root Diameter [in]	0.820
BackDrive Holding Torque [ft-lb]	1.5
Tare Drag Torque [in-lb]	4

Performance Specifications

Maximum Allowable Input [hp]	1.50
Maximum Input Torque [in-lb]	26
Maximum Worm Speed at Rated Load [rpm]	1800
Maximum Load at 1750 RPM [lb]	4000
Starting Torque	1.5 x Running Torque

Weight

Base 0 Travel [lb]	18
Per Inch of Travel [lb]	0.60
Grease [lb]	0.5