

ActionJac 10HL-BSJ-DC 8:1

Call 800-321-7800 or visit us online at www.nookindustries.com to configure and order your ActionJac 10HL-BSJ-DC 8:1 today!

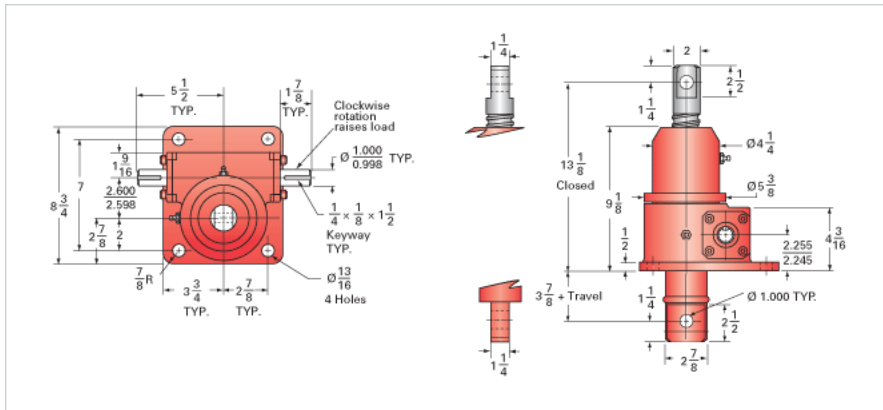

Details

| | |
|-------------------------------------|--------|
| Capacity [Ton] | 10 |
| Gear Ratio | 8:1 |
| Turns of Worm per Inch Travel | 8 |
| Torque to Raise 1 lb. [in-lb] | 0.0319 |
| Torque to Raise 1 lb. Keyed [in-lb] | 0.0351 |
| Lifting Screw Diameter [in] | 1.50 |
| Screw Lead [in] | 1.000 |
| Root Diameter [in] | 1.140 |
| BackDrive Holding Torque [ft-lb] | 26.0 |
| Tare Drag Torque [in-lb] | 20 |

Performance Specifications

| | |
|--|----------------------|
| Maximum Allowable Input [hp] | 5.00 |
| Maximum Input Torque [in-lb] | 638 |
| Maximum Worm Speed at Rated Load Non-keyed [rpm] | 494 |
| Maximum Worm Speed at Rated Load Keyed [rpm] | 449 |
| Maximum Load at 1750 RPM Non-keyed [lb] | 5645 |
| Maximum Load at 1750 RPM Keyed [lb] | 5132 |
| Starting Torque | 1.5 x Running Torque |

Weight

| | |
|-------------------------|------|
| Base 0 Travel [lb] | 50 |
| Per Inch of Travel [lb] | 0.80 |
| Grease [lb] | 1.5 |