

ActionJac 10-BSJ-DC 24:1

Call 800-321-7800 or visit us online at www.nookindustries.com to configure and order your ActionJac 10-BSJ-DC 24:1 today!

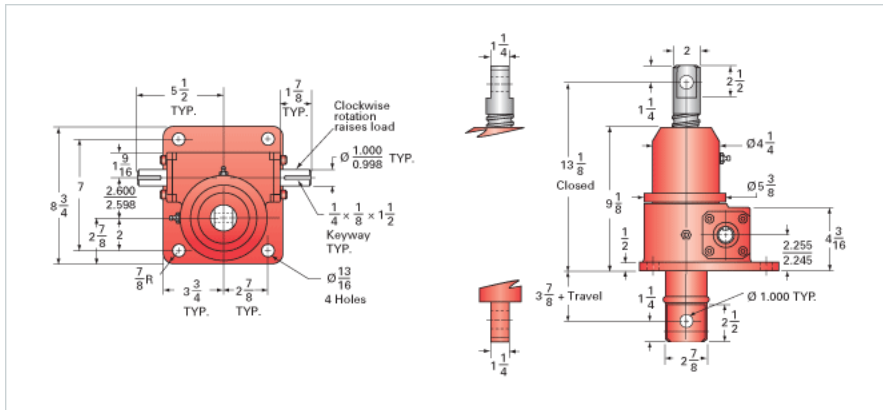

Details

Capacity [Ton]	10
Gear Ratio	24:1
Turns of Worm per Inch Travel	50.66
Torque to Raise 1 lb. [in-lb]	0.0077
Torque to Raise 1 lb. Keyed [in-lb]	0.0085
Lifting Screw Diameter [in]	1.50
Screw Lead [in]	0.473
Root Diameter [in]	1.140
BackDrive Holding Torque [ft-lb]	4.0
Tare Drag Torque [in-lb]	20

Performance Specifications

Maximum Allowable Input [hp]	1.50
Maximum Input Torque [in-lb]	153
Maximum Worm Speed at Rated Load Non-keyed [rpm]	618
Maximum Worm Speed at Rated Load Keyed [rpm]	556
Maximum Load at 1750 RPM Non-keyed [lb]	7016
Maximum Load at 1750 RPM Keyed [lb]	6355
Starting Torque	1.5 x Running Torque

Weight

Base 0 Travel [lb]	50
Per Inch of Travel [lb]	0.80
Grease [lb]	1.5