

NH35LER

Call 800-321-7800 or visit us online at www.nookindustries.com to configure and order your NH35LER today!

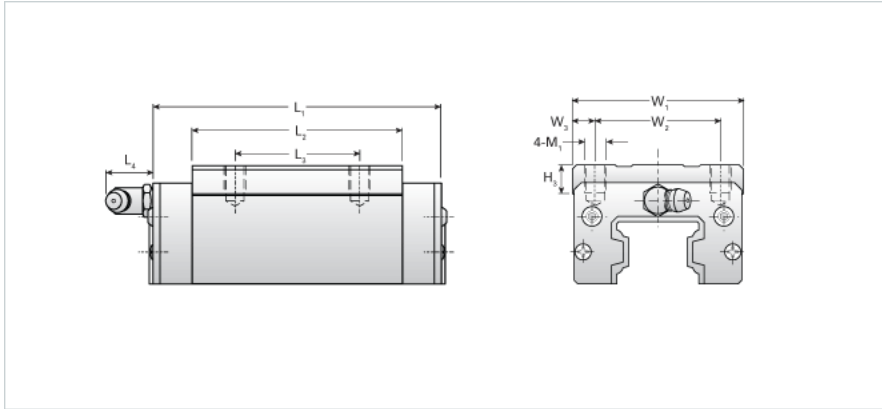
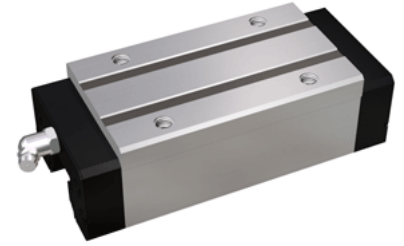

Details	
Size [mm]	35
Dimensions	
L1 [mm]	141
L2 [mm]	109
L3 [mm]	72
L4 [mm]	12
M1 x l	M8X12
H3 [mm]	10
W1 [mm]	70
W2 [mm]	50
W3 [mm]	10
Forces and Torques	
Basic Load Ratings C [kN]	50.30
Basic Load Ratings C [lbf]	11306
Basic Load Ratings C0 [kN]	81.59
Basic Load Ratings C0 [lbf]	18337
Static Moment Ratings-Ma [kN-m]	1.13
Static Moment Ratings-Ma [lb-in]	9982
Static Moment Ratings-Mb [kN-m]	1.13
Static Moment Ratings-Mb [lb-in]	9982
Static Moment Ratings-Mc [kN-m]	1.64
Static Moment Ratings-Mc [lb-in]	14496
Weight	
Weight-Block [kg]	2.20
Grease Fitting	
Grease Fitting Part Number	B-M6F