

## NH45TB

Call 800-321-7800 or visit us online at [www.nookindustries.com](http://www.nookindustries.com) to configure and order your NH45TB today!

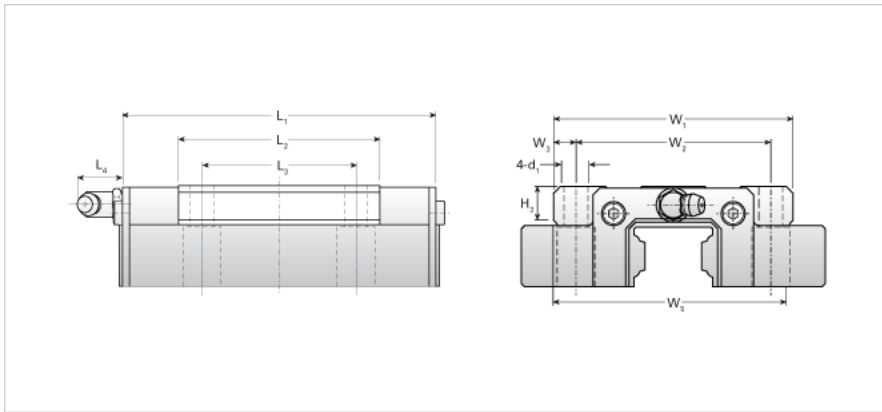
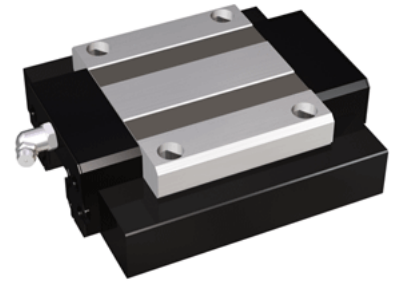

<b>Details</b>	
Size [mm]	45
<b>Dimensions</b>	
L1 [mm]	158
L2 [mm]	102
L3 [mm]	80
L4 [mm]	12
d1 x l	M11x19
H3 [mm]	15
W1 [mm]	120
W2 [mm]	100
W3 [mm]	9
W5 [mm]	147
<b>Forces and Torques</b>	
Basic Load Ratings C [kN]	60.20
Basic Load Ratings C [lbf]	13532
Basic Load Ratings C0 [kN]	95.71
Basic Load Ratings C0 [lbf]	21510
Static Moment Ratings-Ma [kN-m]	1.30
Static Moment Ratings-Ma [lb-in]	11544
Static Moment Ratings-Mb [kN-m]	1.30
Static Moment Ratings-Mb [lb-in]	11544
Static Moment Ratings-Mc [kN-m]	2.30
Static Moment Ratings-Mc [lb-in]	20398
<b>Weight</b>	
Weight-Block [kg]	2.70
<b>Grease Fitting</b>	
Grease Fitting Part Number	B-PT-1/8