

NH65TR

Call 800-321-7800 or visit us online at www.nookindustries.com to configure and order your NH65TR today!

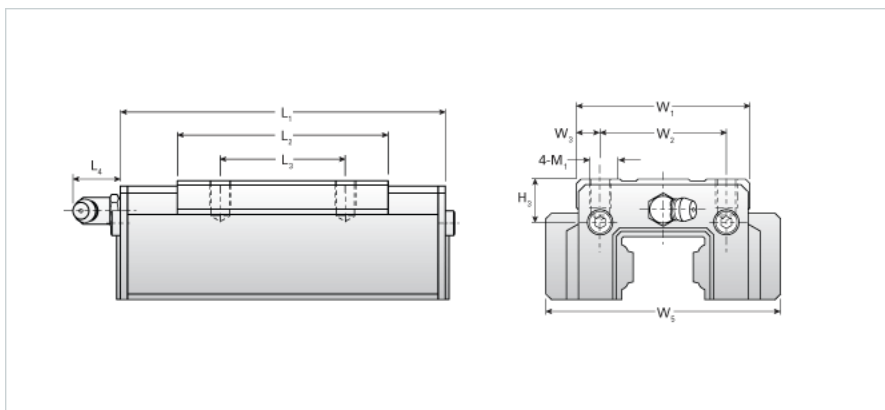
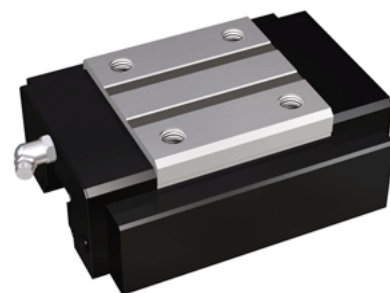

Details	
Size [mm]	65
Dimensions	
H3 [mm]	23
L1 [mm]	225
L2 [mm]	148
L3 [mm]	90
L4 [mm]	23
M1 x l	M16x20
W1 [mm]	126
W2 [mm]	90
W3 [mm]	18
W5 [mm]	162
Forces and Torques	
Basic Load Ratings C [kN]	141.11
Basic Load Ratings C [lbf]	31714
Basic Load Ratings C0 [kN]	215.15
Basic Load Ratings C0 [lbf]	48354
Static Moment Ratings-Ma [kN-m]	4.21
Static Moment Ratings-Ma [lb-in]	37237
Static Moment Ratings-Mb [kN-m]	4.21
Static Moment Ratings-Mb [lb-in]	37237
Static Moment Ratings-Mc [kN-m]	7.38
Static Moment Ratings-Mc [lb-in]	65360
Weight	
Weight-Block [kg]	8.70
Grease Fitting	
Grease Fitting Part Number	B-PT 1/8