

NH30TR

Call 800-321-7800 or visit us online at www.nookindustries.com to configure and order your NH30TR today!

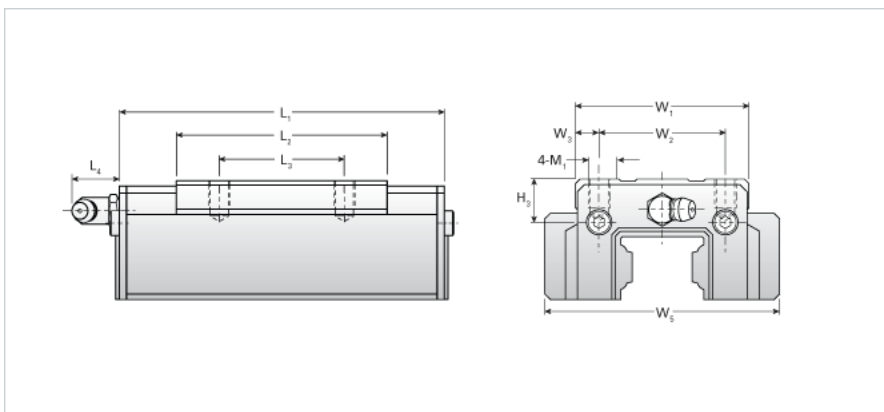
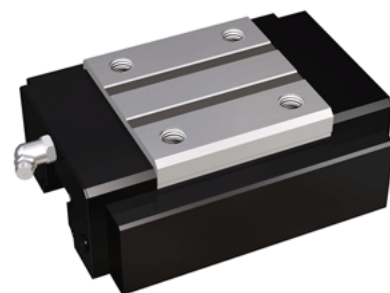

Details	
Size [mm]	30
Dimensions	
H3 [mm]	8
L1 [mm]	102
L2 [mm]	59
L3 [mm]	40
L4 [mm]	10
M1 x l	M8X10
W1 [mm]	60
W2 [mm]	40
W3 [mm]	10
W5 [mm]	81
Forces and Torques	
Basic Load Ratings C [kN]	25.00
Basic Load Ratings C [lbf]	5620
Basic Load Ratings C0 [kN]	39.71
Basic Load Ratings C0 [lbf]	8926
Static Moment Ratings-Ma [kN-m]	0.31
Static Moment Ratings-Ma [lb-in]	2778
Static Moment Ratings-Mb [kN-m]	0.31
Static Moment Ratings-Mb [lb-in]	2778
Static Moment Ratings-Mc [kN-m]	0.62
Static Moment Ratings-Mc [lb-in]	5468
Weight	
Weight-Block [kg]	0.75
Grease Fitting	
Grease Fitting Part Number	B-M6F