

## NH55EA

Call 800-321-7800 or visit us online at [www.nookindustries.com](http://www.nookindustries.com) to configure and order your NH55EA today!

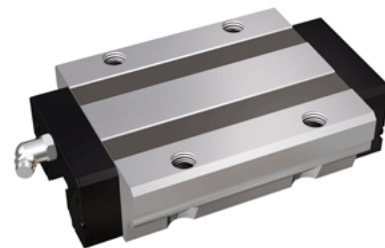

<b>Details</b>	
Size [mm]	55
<b>Dimensions</b>	
L1 [mm]	159
L2 [mm]	124
L3 [mm]	95
L4 [mm]	16
H3 [mm]	17
W1 [mm]	140
W2 [mm]	116
W3 [mm]	12
M1	M14
<b>Forces and Torques</b>	
Basic Load Ratings C [kN]	90.02
Basic Load Ratings C [lbf]	20232
Basic Load Ratings C0 [kN]	137.09
Basic Load Ratings C0 [lbf]	30811
Static Moment Ratings-Ma [kN-m]	2.22
Static Moment Ratings-Ma [lb-in]	19617
Static Moment Ratings-Mb [kN-m]	2.22
Static Moment Ratings-Mb [lb-in]	19617
Static Moment Ratings-Mc [kN-m]	4.16
Static Moment Ratings-Mc [lb-in]	37671
<b>Weight</b>	
Weight-Block [kg]	5.10
<b>Grease Fitting</b>	
Grease Fitting Part Number	B-PT 1/8