

## NH-55

Call 800-321-7800 or visit us online at [www.nookindustries.com](http://www.nookindustries.com) to configure and order your NH-55 today!

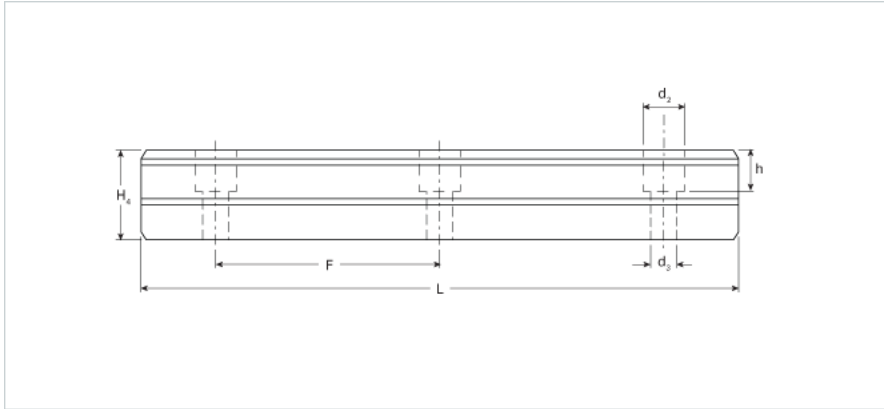

Details	
Size [mm]	55
Type	Standard
Dimensions	
d2 [mm]	23
d3 [mm]	16
h [mm]	24
H4 [mm]	48
F [mm]	120
W [mm]	53
Maximum Length [mm]	3000
Weight	
Weights-Rail [kg/m]	16.5