

DLR 120

Call 800-321-7800 or visit us online at www.nookindustries.com to configure and order your DLR 120 today!

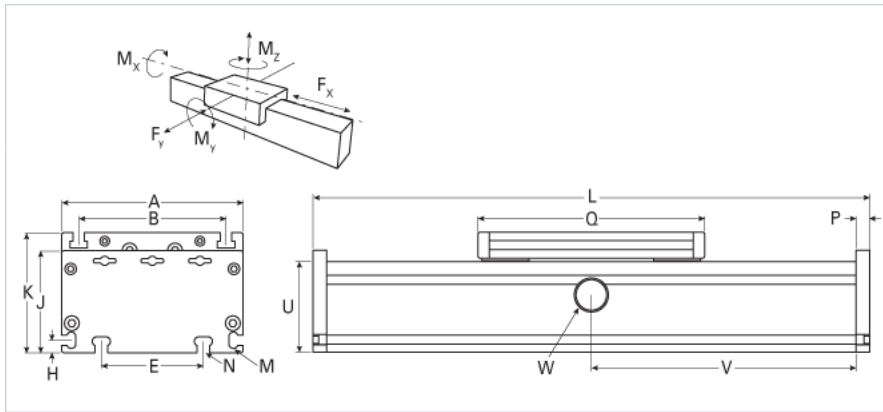
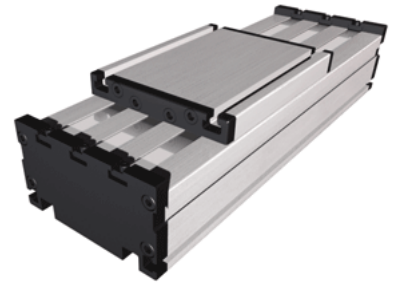

| Details | |
|---|---------|
| Size | 120 |
| Dimensions | |
| Basic Length L [mm] | 200 |
| A [mm] | 120 |
| B [mm] | 96 |
| E [mm] | 78 |
| H [mm] | 10 |
| J [mm] | 68 |
| K [mm] | 79 |
| M | M5 |
| N | M6 |
| O | M6 |
| P [mm] | 10 |
| Q [mm] | 156 |
| U [mm] | 60 |
| Speed | |
| Speed Maximum [m/s] | 4 |
| Forces and Torques | |
| Fx dynamic [N] | - |
| Fy dynamic [N] | 900 |
| Fz dynamic [N] | 1000 |
| Mx dynamic [Nm] | 125 |
| My dynamic [Nm] | 120 |
| Mz dynamic [Nm] | 90 |
| Fx static [N] | - |
| Fy static [N] | 1100 |
| Fz static [N] | 1250 |
| Mx static [Nm] | 150 |
| My static [Nm] | 140 |
| Mz static [Nm] | 100 |
| Geometrical moments of inertia of aluminum profile | |
| Elastic modulus [N/mm ²] | 70000 |
| Ix [mm ⁴] | 660000 |
| Iy [mm ⁴] | 3860000 |
| Weight | |
| Additional Weight per 100 mm [kg] {.00} | 0.71 |
| Basic Weight [kg] | 3.2 |