

DLT 120

Call 800-321-7800 or visit us online at www.nookindustries.com to configure and order your DLT 120 today!

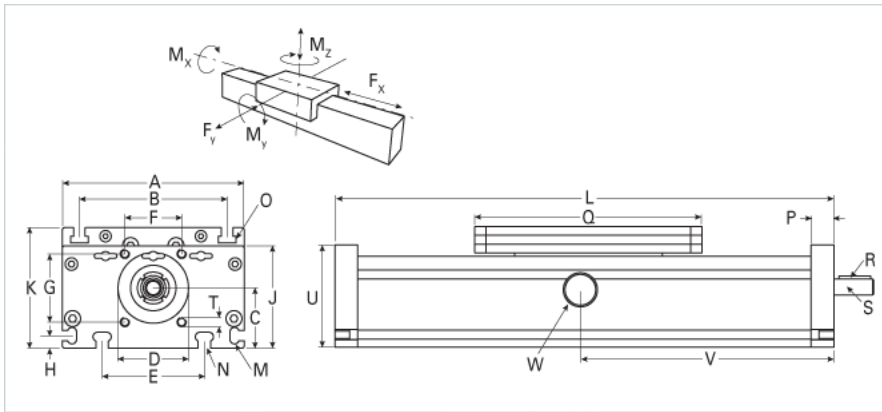

Details	
Size	120
Screw Options	18x4/18x8
Screw Type	Trapexoidal
Dimensions	
Basic Length L [mm]	200
A [mm]	120
B [mm]	96
C [mm]	39
D [mm]	47
E [mm]	78
F [mm]	42
H [mm]	10
J [mm]	68
K [mm]	79
M	M 5
N	M 6
O	M 6
P [mm]	15
Q [mm]	156
Shaft R Key [mm]	3x3x25
Shaft S Diameter x Length [mm]	10 h6 x 27
T	M 6
Forces and Torques	
No Load Torque-Dynamic	0.9
Fx dynamic [N]	800
Fy dynamic [N]	900
Fz dynamic [N]	1000
Mx dynamic [Nm]	125
My dynamic [Nm]	120
Mz dynamic [Nm]	90
Fx static [N]	900
Fy static [N]	1100
Fz static [N]	1250
Mx static [Nm]	150
My static [Nm]	140
Mz static [Nm]	100
Geometrical moments of inertia of aluminum profile	
Elastic modulus [N/mm ²]	70000
Ix [mm ⁴]	660000
Iy [mm ⁴]	3860000
Weight	
Additional Weight per 100 mm [kg]	0.92
Basic Weight [kg]	3.9