

## QSR 60

Call 800-321-7800 or visit us online at [www.nookindustries.com](http://www.nookindustries.com) to configure and order your QSR 60 today!

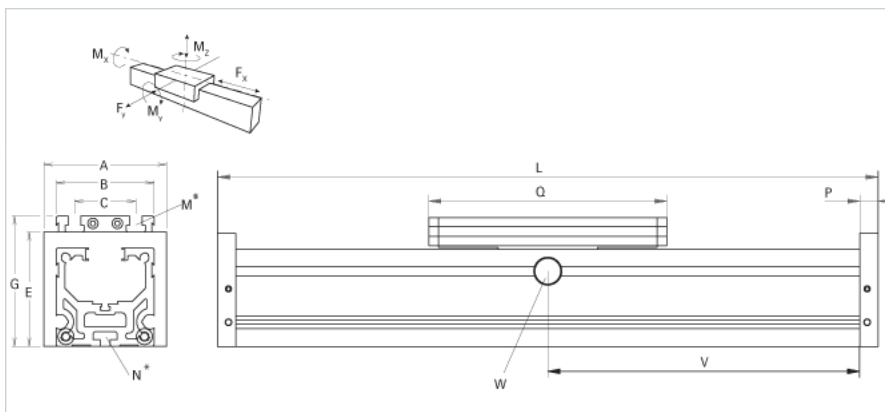

<b>Details</b>	
Size	60
<b>Dimensions</b>	
Basic Length L [mm]	205
A [mm]	80
B [mm]	60
C [mm]	36
E [mm]	60
G [mm]	79
M	M6
N	M5
P [mm]	12
Q [mm]	177
<b>Speed</b>	
Speed Maximum [m/s]	5
<b>Forces and Torques</b>	
Fx [N] 10000 km	-
Fy [N] 10000 km	990
Fz [N] 10000 km	2500
Mx [Nm] 10000 km	23
My [Nm] 10000 km	73
Mz [Nm] 10000 km	70
Fx [N] 5000 km	-
Fy [N] 5000 km	1410
Fz [N] 5000 km	3520
Mx [Nm] 5000 km	33
My [Nm] 5000 km	104
Mz [Nm] 5000 km	100
<b>Geometrical moments of inertia of aluminum profile</b>	
Elastic modulus [N/mm <sup>2</sup> ]	70000
Ix [mm <sup>4</sup> ]	430000
Iy [mm <sup>4</sup> ]	480000
<b>Weight</b>	
Additional Weight per 100 mm [kg]	0.50
Basic Weight [kg]	1.8