

UL 40

Call 800-321-7800 or visit us online at www.nookindustries.com to configure and order your UL 40 today!

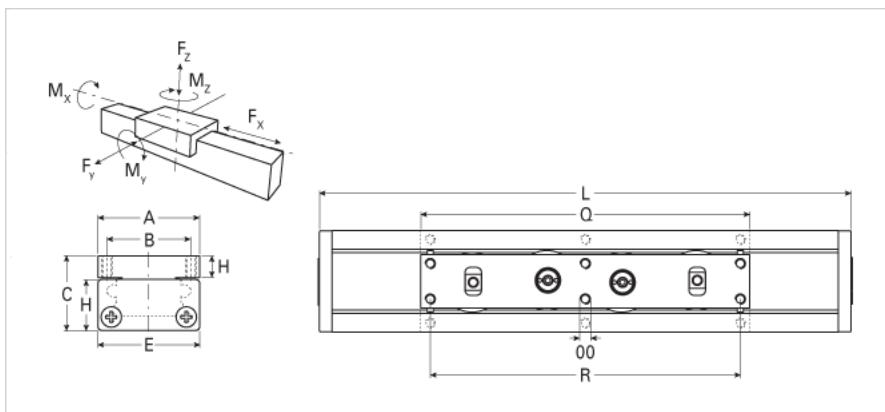
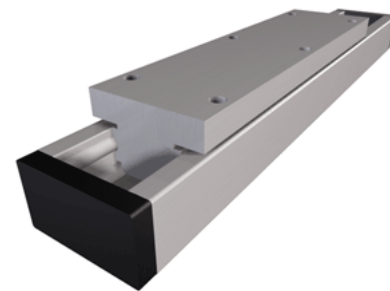

Details	
Size	40
Dimensions	
A [mm]	40
B [mm]	31
C [mm]	33
E [mm]	40
H [mm]	22
Basic Length L [mm]	160
OO	M5x8
P [mm]	6
Q [mm]	146
R [mm]	120
S [mm]	6.8
T [mm]	7.3
Speed	
Speed Maximum [m/s]	4
Forces and Torques	
Fx dynamic [N]	-
Fy dynamic [N]	700
Fz dynamic [N]	650
Mx dynamic [N]	20
My dynamic [N]	18
Mz dynamic [N]	25
Fx static [N]	-
Fy static [N]	1200
Fz static [N]	900
Mx static [N]	25
My static [N]	32
Mz static [N]	35
Geometrical moments of inertia of aluminum profile	
Elastic modulus [N/mm ²]	70000
Ix [mm ⁴]	15700
Iy [mm ⁴]	65400
Weight	
Additional Weight per 100 mm [kg]	0.13
Basic Weight [kg]	1.2