

ELRZ 125

Call 800-321-7800 or visit us online at www.nookindustries.com to configure and order your ELRZ 125 today!

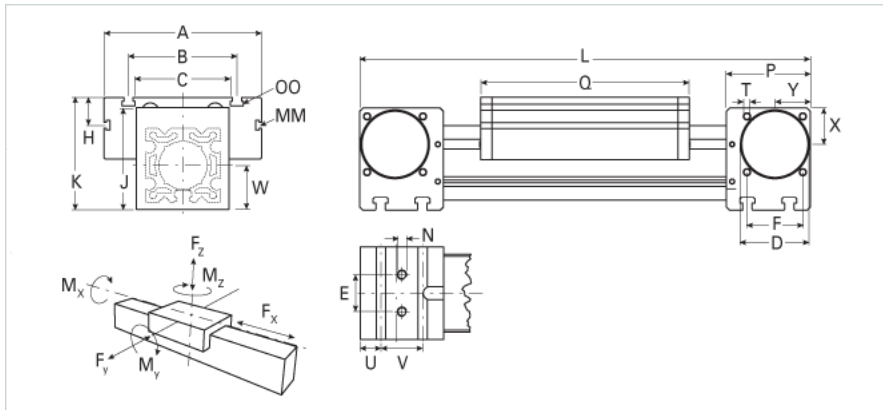
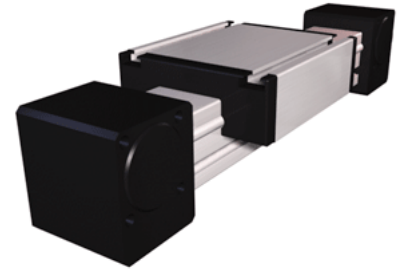

Details	
Size	125
Dimensions	
Basic Length L [mm]	625
A [mm]	295
B [mm]	200
C [mm]	160
D [mm]	110
E [mm]	60
F [mm]	100
G [mm]	-
H [mm]	30
J [mm]	167
K [mm]	191
MM	M10
N	M12
OO	M12
P [mm]	130
Q [mm]	365
T-Diameter	M12
U [mm]	38
V [mm]	50
W [mm]	82
X [mm]	60
Y [mm]	60
Forces and Torques	
Fx dynamic [N]	-
Fy dynamic [N]	9000
Fz dynamic [N]	4500
Mx dynamic [Nm]	1450
My dynamic [Nm]	600
Mz dynamic [Nm]	1150
Fx static [N]	-
Fy static [N]	12000
Fz static [N]	6000
Mx static [Nm]	600
My static [Nm]	750
Mz static [Nm]	1350
Geometrical moments of inertia of aluminum profile	
Elastic modulus [N/mm ²]	70000
Ix [mm ⁴]	10200000
Iy [mm ⁴]	10200000
Weight	
Additional Weight per 100 mm [kg]	2.05
Basic Weight [kg] [.0]	28.3