

ELR 40

Call 800-321-7800 or visit us online at www.nookindustries.com to configure and order your ELR 40 today!

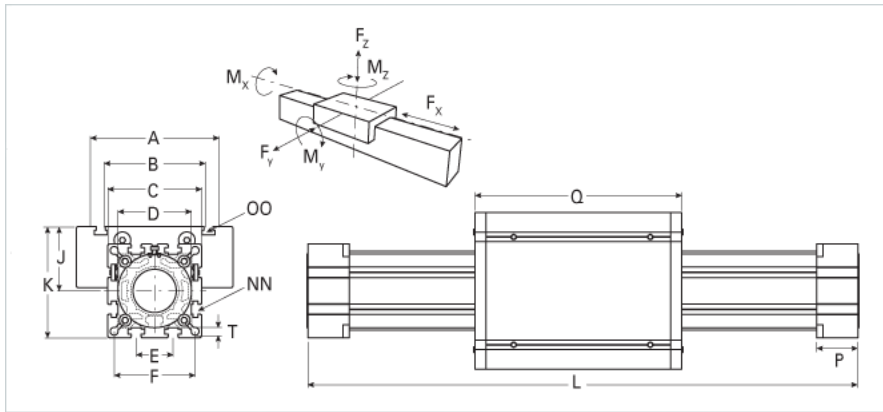
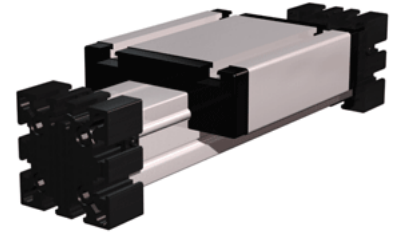

| Details | |
|---|--------|
| Size | 40 |
| Dimensions | |
| Basic Length L [mm] | 175 |
| A [mm] | 100 |
| B [mm] | 66 |
| C [mm] | 58 |
| D [mm] | 48x1 |
| E [mm] | 18 |
| F [mm] | 47 |
| G [mm] | - |
| H [mm] | - |
| K [mm] | 64 |
| MM | - |
| NN | M6 |
| OO | M6 |
| P [mm] | 25 |
| Q [mm] | 122 |
| T-Diameter [mm] | 6.5 |
| Forces and Torques | |
| Fx dynamic [N] | - |
| Fy dynamic [N] | 700 |
| Fz dynamic [N] | 650 |
| Mx dynamic [Nm] | 20 |
| My dynamic [Nm] | 18 |
| Mz dynamic [Nm] | 25 |
| Fx static [N] | - |
| Fy static [N] | 1200 |
| Fz static [N] | 900 |
| Mx static [Nm] | 25 |
| My static [Nm] | 32 |
| Mz static [Nm] | 35 |
| No-load torque Maximum [m/s] | 4 |
| Geometrical moments of inertia of aluminum profile | |
| Elastic modulus [N/mm ²] | 70000 |
| Ix [mm ⁴] | 132000 |
| Iy [mm ⁴] | 134000 |
| Weight | |
| Additional Weight per 100 mm [kg] | 0.23 |
| Basic Weight [kg] | 0.9 |