

PowerTrax NSR-16

Call 800-321-7800 or visit us online at www.nookindustries.com to configure and order your PowerTrax NSR-16 today!

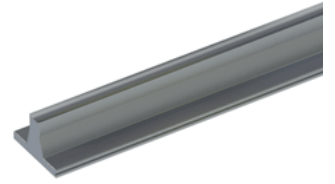
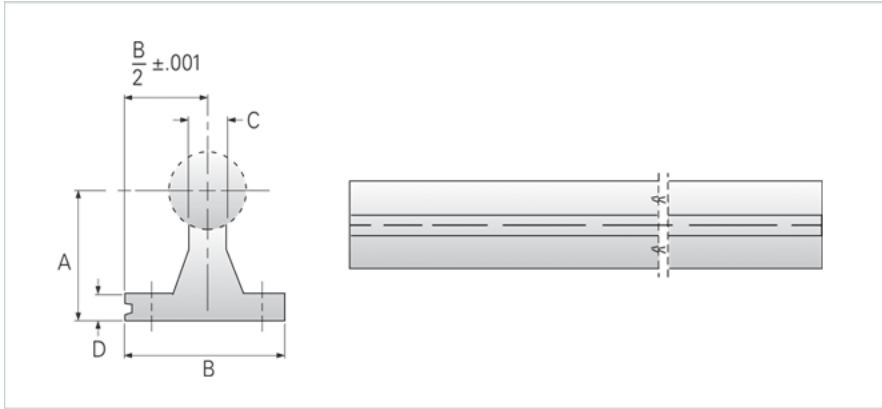

Product Info	
Nominal Shaft Diameter [in]	1.00
Dimensions	
A +/-0.002 [in]	1.750
B [in]	2.13
C [in]	0.500
D [in]	0.250
Part Number	
24" Part Number	NSR-16-24
36" Part Number	NSR-16-36
48" Part Number	NSR-16-48
Weight	
Weight Per Foot [lb]	1.40