

## PowerTrax NSR-10-PD

Call 800-321-7800 or visit us online at [www.nookindustries.com](http://www.nookindustries.com) to configure and order your PowerTrax NSR-10-PD today!

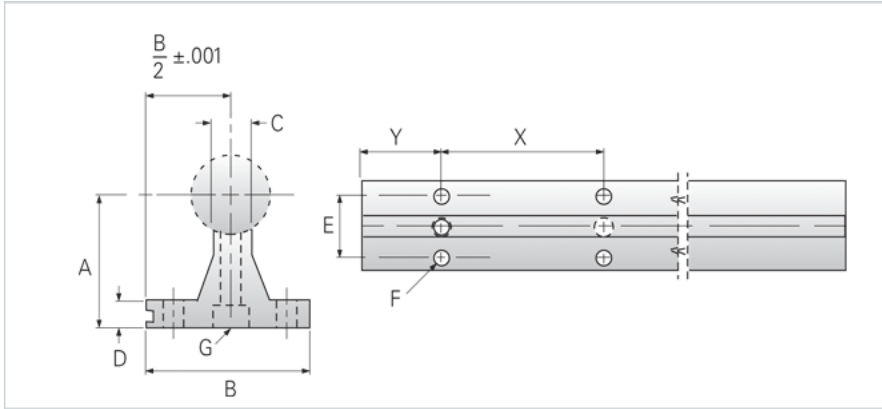

### Product Info

Nominal Shaft Diameter [in] 0.63

### Dimensions

A +/-0.002 [in] 1.125

B [in] 1.63

C [in] 0.313

D [in] 0.250

E [in] 1.13

X 4

Y 2

F Bolt 8

F Hole [in] 0.193

G Hole [in] 0.193

G Screw 8-32x7/8

### Part Number

24" Part Number NSR-10-PD-24

36" Part Number NSR-10-PD-36

48" Part Number NSR-10-PD-48

### Weight

Weight Per Foot [lb] 0.70