

PowerTrax NSR-8-PD

Call 800-321-7800 or visit us online at www.nookindustries.com to configure and order your PowerTrax NSR-8-PD today!

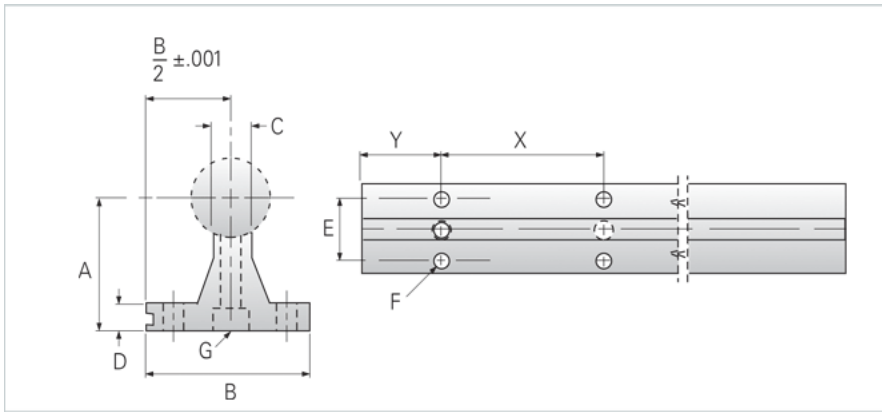

Product Info

Nominal Shaft Diameter [in] 0.50

Dimensions

A +/-0.002 [in] 1.125

B [in] 1.50

C [in] 0.250

D [in] 0.188

E [in] 1.00

X 4

Y 2

F Bolt 6

F Hole [in] 0.169

G Hole [in] 0.169

G Screw 6-32x7/8

Part Number

24" Part Number NSR-8-PD-24

36" Part Number NSR-8-PD-36

48" Part Number NSR-8-PD-48

Weight

Weight Per Foot [lb] 0.50