

NLR-16-PD

Call 800-321-7800 or visit us online at www.nookindustries.com to configure and order your NLR-16-PD today!

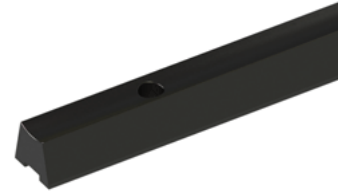
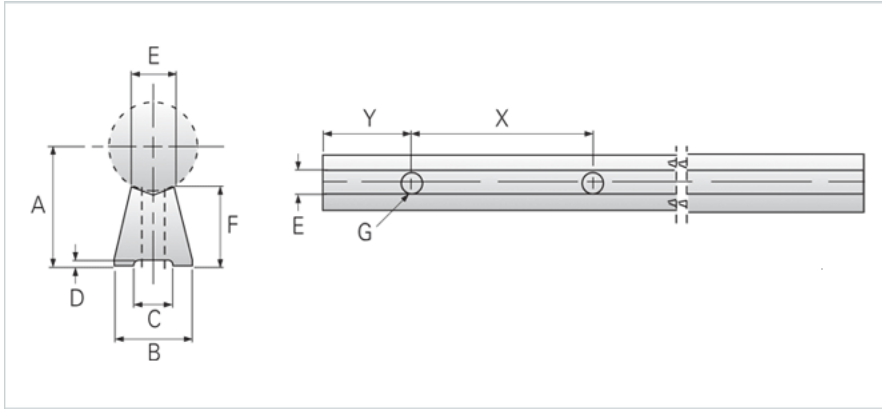

Product Info	
Nominal Shaft Diameter [in]	1.00
Dimensions	
A +/-0.002 [in]	1.000
B [in]	0.69
C [in]	0.281
D [in]	0.06
E [in]	0.456
F [in]	0.551
G - Hole [in]	0.281
X	6
Y	3
G - Bolt	1/4
Part Number	
12" Part Number	NLR-16-PD-12
24" Part Number	NLR-16-PD-24
36" Part Number	NLR-16-PD-36
48" Part Number	NLR-16-PD-48
Weight	
Weight Per Foot [lb]	0.36