

## NSR-32-PDA

Call 800-321-7800 or visit us online at [www.nookindustries.com](http://www.nookindustries.com) to configure and order your NSR-32-PDA today!

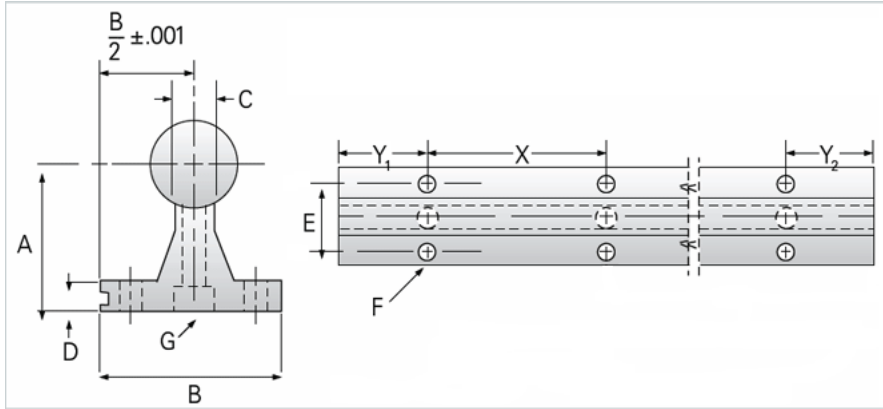
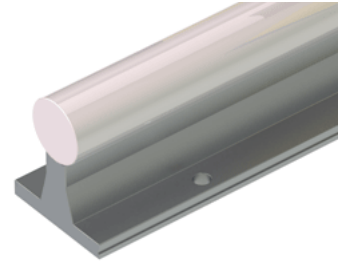

### Product Info

Nominal Diameter [in] 2.00

### Dimensions

A +/-0.002 [in] 3.250

B [in] 3.75

C [in] 0.875

D [in] 0.500

E [in] 2.75

G - Hole [in] 0.531

X [in] 8

F - Bolt 1/2"

F - Hole [in] 0.531

G - Screw 1/2-13x2-1/2

### Weight

Weight Per Foot [lb] 14.88