

## NSR-16-PDA

Call 800-321-7800 or visit us online at [www.nookindustries.com](http://www.nookindustries.com) to configure and order your NSR-16-PDA today!

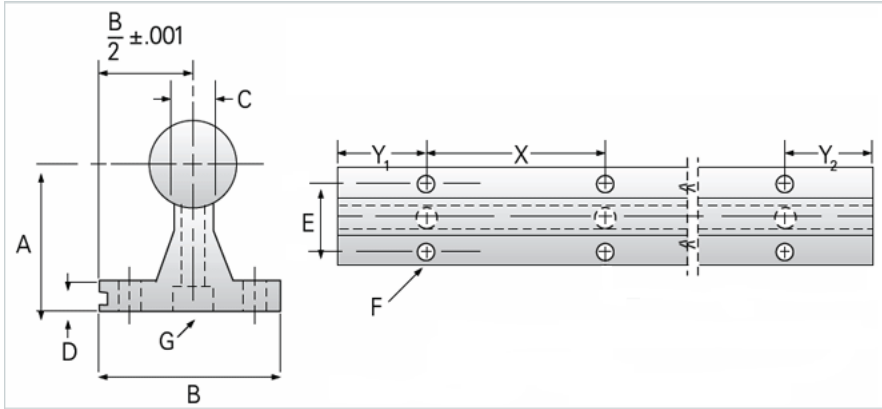
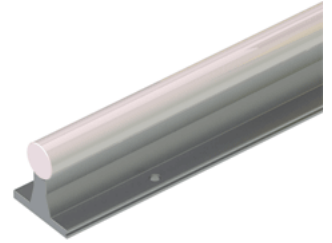

### Product Info

Nominal Diameter [in] 1.00

### Dimensions

A +/-0.002 [in] 1.750

B [in] 2.13

C [in] 0.500

D [in] 0.250

E [in] 1.50

G - Hole [in] 0.281

X [in] 6

F - Bolt 1/4"

F - Hole [in] 0.281

G - Screw 1/4-20x1-1/2

### Weight

Weight Per Foot [lb] 4.06