

NSR-8-PDA

Call 800-321-7800 or visit us online at www.nookindustries.com to configure and order your NSR-8-PDA today!

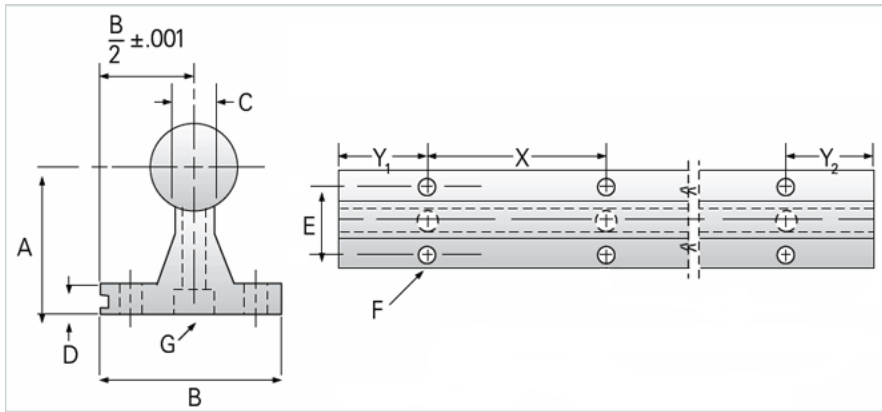
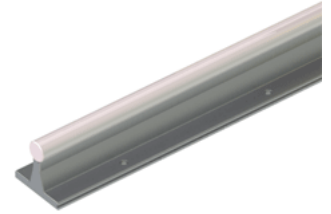

Product Info

Nominal Diameter [in] 0.50

Dimensions

A +/-0.002 [in] 1.125

B [in] 1.50

C [in] 0.250

D [in] 0.188

E [in] 1.00

G - Hole [in] 0.169

X [in] 4

F - Bolt 6

F - Hole [in] 0.169

G - Screw 6-32x7/8

Weight

Weight Per Foot [lb] 1.26