

## DD-3024-HD/05XX

Call 800-321-7800 or visit us online at [www.nookindustries.com](http://www.nookindustries.com) to configure and order your DD-3024-HD/05XX today!

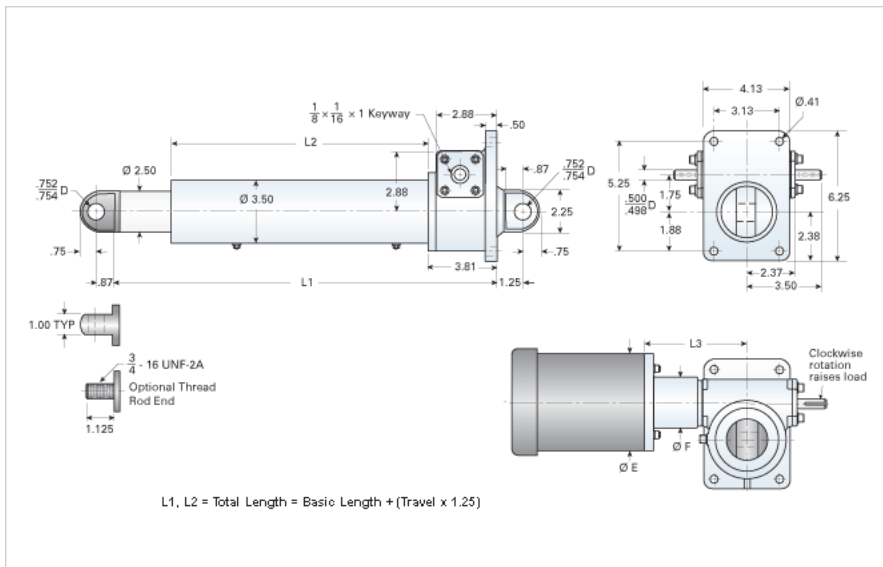

### Performance Specifications

Travel Rate [in/min]	30
Dynamic Capacity [lb]	2700
Rated Life [in]	3000000
Motor Horse Power [hp]	0.5
Maximum Rod Reaction Torque [in-lb]	197
Std. Brake Torque [ft-lb]	3
Approximate Stopping Distance No Load [in]	0.03
Approximate Stopping Distance Full Load [in]	0.05

### Details

Gear Ratio	24:1
Input Turns Per Inch Of Travel	58.1
Torque To Raise 1 lb. [in-lb]	0.007
Max Capacity [lb]	6000
Max HP [hp]	0.5

### Weight

Basic Weight [lb]	38
Per Inch of Travel [lb]	1.31

### Tube Dimensions

L1 Basic Length [in]	12.44
L2 Basic Length [in]	7.13

### NEMA 42 Dimensions

L3 [in]	-
E [in]	-
F [in]	-

### NEMA 48 Dimensions

L3 [in]	-
E [in]	-
F [in]	-

### NEMA 56C Dimensions

L3 [in]	6.25
E [in]	6.62
F [in]	3.50

### NEMA 182TC Dimensions

L3 [in]	-
E [in]	-
F [in]	-

### NEMA 184TC Dimensions

L3 [in]	-
E [in]	-
F [in]	-

### NEMA 213TC Dimensions

L3 [in]	-
E [in]	-
F [in]	-