

DD-2524-HD/05XX

Call 800-321-7800 or visit us online at www.nookindustries.com to configure and order your DD-2524-HD/05XX today!

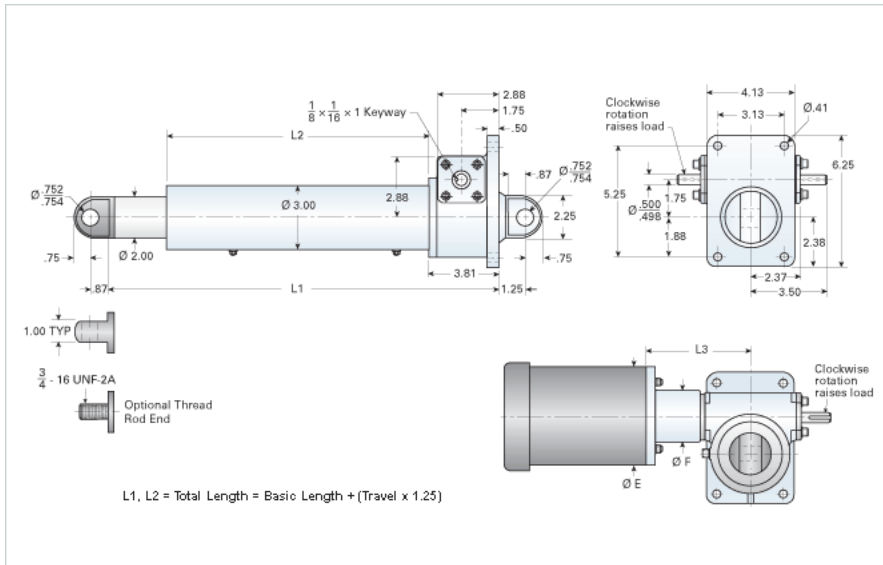

Performance Specifications

Travel Rate [in/min]	18
Dynamic Capacity [lb]	4450
Rated Life [in]	380000
Motor Horse Power [hp]	0.5
Maximum Rod Reaction Torque [in-lb]	197
Std. Brake Torque [ft-lb]	3
Approximate Stopping Distance No Load [in]	0.02
Approximate Stopping Distance Full Load [in]	0.03

Details

Gear Ratio	24:1
Input Turns Per Inch Of Travel	96
Torque To Raise 1 lb. [in-lb]	0.0042
Max Capacity [lb]	5000
Max HP [hp]	0.5

Weight

Basic Weight [lb]	33
Per Inch of Travel [lb]	1.05

Tube Dimensions

L1 Basic Length [in]	12.44
L2 Basic Length [in]	7.13

NEMA 42 Dimensions

L3 [in]	-
E [in]	-
F [in]	-

NEMA 48 Dimensions

L3 [in]	-
E [in]	-
F [in]	-

NEMA 56C Dimensions

L3 [in]	6.25
E [in]	6.62
F [in]	3.50

NEMA 182TC Dimensions

L3 [in]	-
E [in]	-
F [in]	-

NEMA 184TC Dimensions

L3 [in]	-
E [in]	-
F [in]	-

NEMA 213TC Dimensions

L3 [in]	-
E [in]	-
F [in]	-