

DD-1008-A4/20XX

Call 800-321-7800 or visit us online at www.nookindustries.com to configure and order your DD-1008-A4/20XX today!

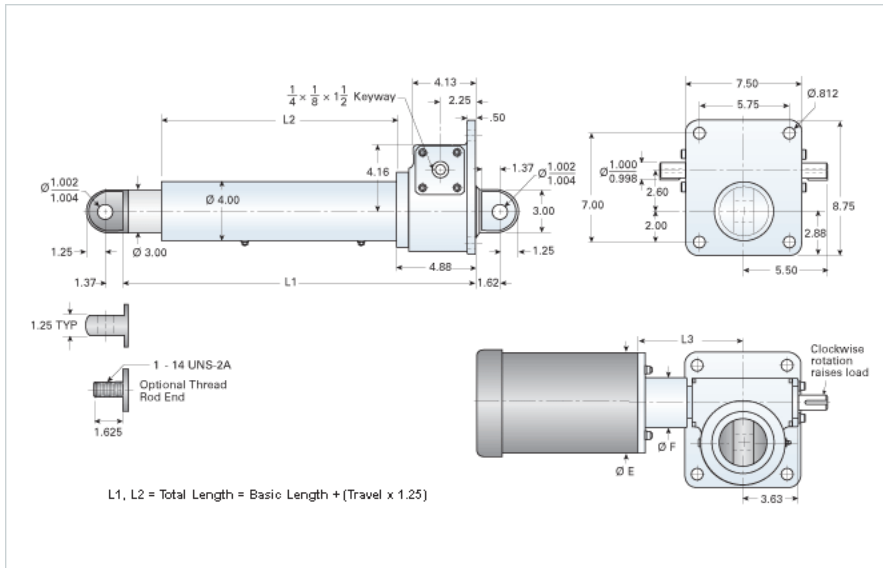

Performance Specifications

Travel Rate [in/min]	54
Dynamic Capacity [lb]	2000
Motor Horse Power (ref.) [hp]	2
Std. Brake Torque [ft-lb]	10
Approximate Stopping Distance No Load [in]	0.20
Maximum Rod Reaction Torque [in-lb]	362

Details

Gear Ratio	8:1
Input Turns Per Inch Of Travel	32
Torque To Raise 1 lb. [in-lb]	0.0314
Max Capacity [lb]	20000
Max HP [hp]	5

Weight

Basic Weight [lb]	77
Per Inch of Travel [lb]	2.50

Tube Dimensions

L1 Basic Length [in]	12.88
L2 Basic Length [in]	6.50

NEMA 42 Dimensions

L3 [in]	-
E [in]	-
F [in]	-

NEMA 48 Dimensions

L3 [in]	-
E [in]	-
F [in]	-

NEMA 56C Dimensions

L3 [in]	8.25
E [in]	6.75
F [in]	4.38

NEMA 182TC Dimensions

L3 [in]	-
E [in]	-
F [in]	-

NEMA 184TC Dimensions

L3 [in]	-
E [in]	9.25
F [in]	-

NEMA 213TC Dimensions

L3 [in]	-
E [in]	-
F [in]	-