

## DD-2524-A4/05XX

Call 800-321-7800 or visit us online at [www.nookindustries.com](http://www.nookindustries.com) to configure and order your DD-2524-A4/05XX today!

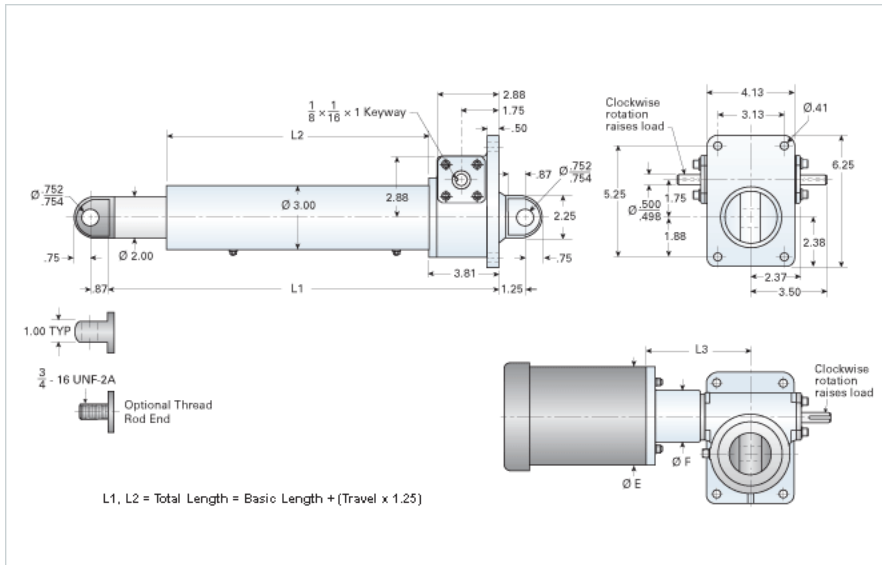

### Performance Specifications

Travel Rate [in/min]	18
Dynamic Capacity [lb]	1880
Motor Horse Power (ref.) [hp]	0.5
Std. Brake Torque [ft-lb]	3
Approximate Stopping Distance No Load [in]	0.02
Maximum Rod Reaction Torque [in-lb]	197

### Details

Gear Ratio	24:1
Input Turns Per Inch Of Travel	96
Torque To Raise 1 lb. [in-lb]	0.0106
Max Capacity [lb]	5000
Max HP [hp]	0.5

### Weight

Basic Weight [lb]	30
Per Inch of Travel [lb]	1.00

### Tube Dimensions

L1 Basic Length [in]	10.38
L2 Basic Length [in]	4.75

### NEMA 42 Dimensions

L3 [in]	-
E [in]	-
F [in]	-

### NEMA 48 Dimensions

L3 [in]	-
E [in]	-
F [in]	-

### NEMA 56C Dimensions

L3 [in]	6.25
E [in]	6.62
F [in]	3.50

### NEMA 182TC Dimensions

L3 [in]	-
E [in]	-
F [in]	-

### NEMA 184TC Dimensions

L3 [in]	-
E [in]	-
F [in]	-

### NEMA 213TC Dimensions

L3 [in]	-
E [in]	-
F [in]	-