

RAD-3022-HD/03XX

Call 800-321-7800 or visit us online at www.nookindustries.com to configure and order your RAD-3022-HD/03XX today!

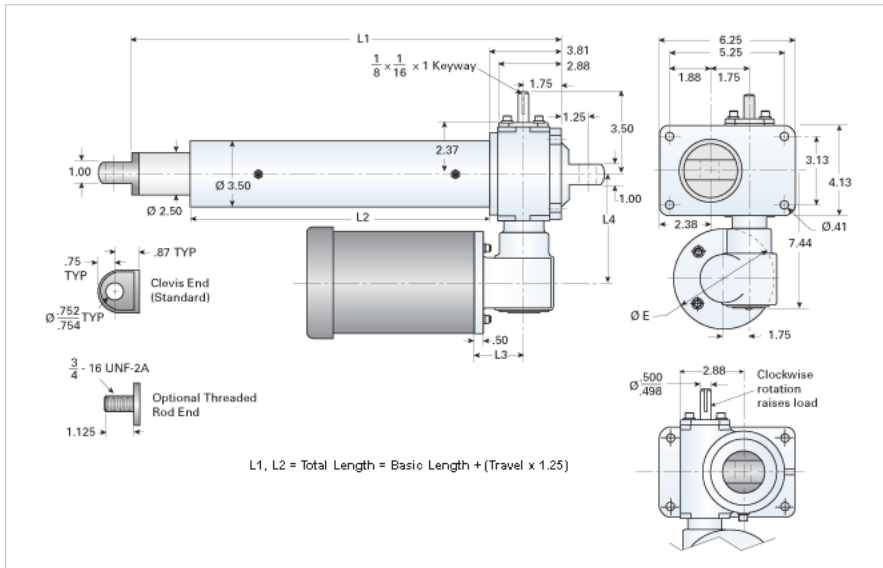

Performance Specifications

Travel Rate [in/min]	5
Dynamic Capacity [lb]	6000
Rated Life [in]	270000
Motor Horse Power	0.33
Maximum Rod Reaction Torque [in-lb]	439
Std. Brake Torque [ft-lb]	3
Approximate Stopping Distance No Load [in]	0.006
Approximate Stopping Distance Full Load [in]	0.006

Details

Gear Ratio Primary Reduction	12:1
Gear Ratio Secondary Reduction	12:1
Input Turns Per Inch Of Travel	348.2
Torque To Raise 1 lb. [in-lb]	0.0026
Max Capacity [lb]	6000
Max HP [hp]	0.25

Weight

Basic Weight [lb]	51
Per Inch of Travel [lb]	1.31

Tube Dimensions

L1 Basic Length [in]	12.44
L2 Basic Length [in]	7.31

NEMA 56C Dimensions

L3 [in]	3.69
L4 [in]	5.63
E [in]	6.69

NEMA 180TC Dimensions

L3 [in]	-
L4 [in]	-
F [in]	-