

RAD-3062-A4/07XX

Call 800-321-7800 or visit us online at www.nookindustries.com to configure and order your RAD-3062-A4/07XX today!

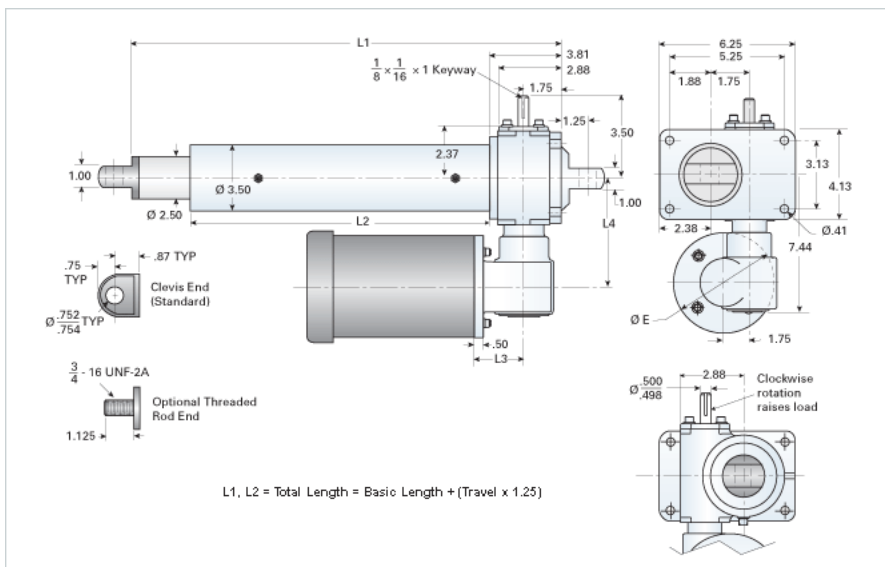

Performance Specifications

Travel Rate [in/min]	6
Dynamic Capacity [lb]	4925
Motor Horse Power	0.75
Maximum Rod Reaction Torque [in-lb]	575
Std. Brake Torque [ft-lb]	3
Approximate Stopping Distance No Load [in]	0.005

Details

Gear Ratio Primary Reduction	6:1
Gear Ratio Secondary Reduction	12:1
Input Turns per Inch of Travel	288
Torque to Raise 1 lb. [in-lb]	0.0043
Max Capacity [lb]	5000
Max HP [hp]	0.75

Weight

Basic Weight [lb]	47
Per Inch of Travel [lb]	1.38

Tube Dimensions

L1 Basic Length [in]	10.50
L2 Basic Length [in]	5.13

NEMA 56C Dimensions

L3 [in]	3.69
L4 [in]	5.63
E [in]	6.69

NEMA 180TC Dimensions

L3 [in]	-
L4 [in]	-
F [in]	-