

RAD-3066-A4/10XX

Call 800-321-7800 or visit us online at www.nookindustries.com to configure and order your RAD-3066-A4/10XX today!

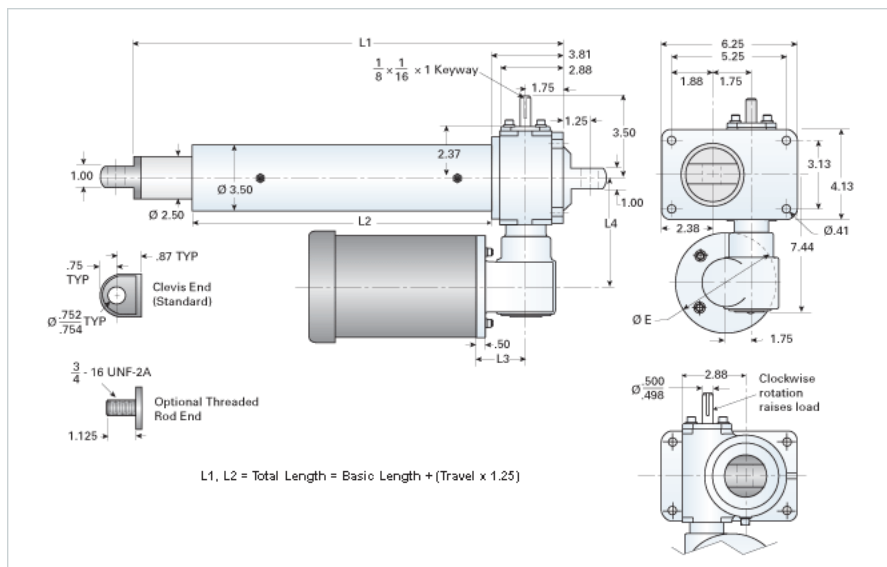

Performance Specifications

Travel Rate [in/min]	12
Dynamic Capacity [lb]	6000
Motor Horse Power	1
Maximum Rod Reaction Torque [in-lb]	702
Std. Brake Torque [ft-lb]	6
Approximate Stopping Distance No Load [in]	0.02

Details

Gear Ratio Primary Reduction	6:1
Gear Ratio Secondary Reduction	6:1
Input Turns per Inch of Travel	144
Torque to Raise 1 lb. [in-lb]	0.0071
Max Capacity [lb]	5000
Max HP [hp]	1

Weight

Basic Weight [lb]	47
Per Inch of Travel [lb]	1.38

Tube Dimensions

L1 Basic Length [in]	10.50
L2 Basic Length [in]	5.13

NEMA 56C Dimensions

L3 [in]	3.69
L4 [in]	5.63
E [in]	6.69

NEMA 180TC Dimensions

L3 [in]	-
L4 [in]	-
F [in]	-